

# PTCB E1 24DC/1A SI-R - Electronic circuit breaker



1135751

<https://www.phoenixcontact.com/us/products/1135751>

Please be informed that the data shown in this PDF document is generated from our online catalog. Please find the complete data in the user documentation. Our general terms of use for downloads are valid.

1-channel, electronic fuse for protecting 24 V loads. Easy potential distribution with terminal blocks from the CLIPLINE complete system. With status output, reset input, and electronic interlock. For installation on DIN rails.



## Your advantages

- Simple application setup due to bridging option to CLIPLINE complete terminal block system
- More space in the control cabinet: narrowest protection on just 6 mm width
- Individual setup for suitable protection, exactly according to your requirements
- Enhanced diagnostic and control options, thanks to integrated status output and reset input
- Optimum protection for cables and sensors as well as NEC Class 2 circuits by means of an additional internal output fuse

## Commercial data

Item number	1135751
Packing unit	1 pc
Minimum order quantity	1 pc
Sales key	CL10
Product key	CLA135
GTIN	4063151069599
Weight per piece (including packing)	34 g
Weight per piece (excluding packing)	27.5 g
Customs tariff number	85363010
Country of origin	DE

## Technical data

### Notes

#### General

Note	
	EN 50121-3-2: Railway applications - Electromagnetic compatibility - Part 3-2: Rolling stock – Apparatus
	Connection for signal line tested in accordance with EN 61000-4-4 with 1 kV; if necessary, customer must provide appropriate protective measures
	Repeated hard short circuits can reduce the melting integral of the integrated backup fuse.

### Product properties

Product type	Device circuit breakers
Product family	PTCB
Type	DIN rail module, one-piece
Number of positions	1

#### Data management status

Article revision	08
------------------	----

#### Insulation characteristics

Protection class	III
Pollution degree	2

### Electrical properties

#### General

Operating voltage	18 V DC ... 30 V DC
Rated voltage	24 V DC
Rated current $I_N$	24 A DC (Total current input)
	1 A DC (Rated current output)
Rated current (pre-adjusted)	1 A
Rated surge voltage	0.5 kV
Tripping method	E (electronic)
Feedback resistance	max. 35 V DC
Required backup fuse	Only required if $I_{max}$ of the power supply > the short-circuit switching capacity. Integrated failsafe element.
Short-circuit switching capacity	300 A
Dielectric strength	max. 35 V DC (Load circuit)
Fuse	electronic
Efficiency	> 99 %
Closed circuit current $I_0$	typ. 8 mA
Power dissipation	typ. 0.15 W (No-load operation)
	< 1.1 W (Nominal operation)
Module initialization time	< 0.55 s

# PTCB E1 24DC/1A SI-R - Electronic circuit breaker



1135751

<https://www.phoenixcontact.com/us/products/1135751>

Waiting time after switch off of a channel	5 s (at overload / short circuit)
Measuring tolerance I	± 15 %
Temperature derating	21 A (Total current at 60°C)
	24 A (Total current at 50°C)
	1 A (Channel current at 60°C)
	1 A (Channel current at 50°C)
MTBF (IEC 61709, SN 29500)	28571428 h (at 25 °C with 21 % load)
	14925373 h (at 40°C with 34.25% load)
	3125000 h (at 60°C with 100% load)
Voltage drop	0.04 V (at 1 A)
Fail-safe element	5 A DC
Contact switching type	without electrical isolation

## Load circuit

Shutdown time	≤ 10 ms (for short circuit > 2.0 x I <sub>N</sub> )
	1 s (1.2 ... 2.0 x I <sub>N</sub> )
Undervoltage switch-off	≤ 17.8 V DC (active)
	≥ 18.8 V DC (inactive)
Overvoltage switch-off	≥ 30.5 V DC (active)
	≤ 29.5 V DC (inactive)
Max. capacitive load	14000 µF (Depending on the current setting and the short-circuit current available)

## Reset

Input voltage range	7 V DC ... 30 V DC (Reset with falling edge)
Current consumption	typ. 0.4 mA (at 24 V DC)
Pulse length	≥ 50 ms (High)
	≥ 50 ms (Low)
Voltage	< 5 V DC (Low state)
	> 8 V DC (High state)
Stripping length	8 mm
Conductor cross section rigid	0.2 mm <sup>2</sup> ... 2.5 mm <sup>2</sup>
Conductor cross section AWG	24 ... 12
Conductor cross section, flexible, with ferrule, with plastic sleeve	0.25 mm <sup>2</sup> ... 2.5 mm <sup>2</sup>
Conductor cross section flexible, with ferrule without plastic sleeve	0.25 mm <sup>2</sup> ... 2.5 mm <sup>2</sup>

## Status output

Output voltage	24 V DC (Error)
	0 V DC (no error)
Output current	max. 0.015 A (Short-circuit-proof)
Stripping length	8 mm
Conductor cross section rigid	0.2 mm <sup>2</sup> ... 4 mm <sup>2</sup>
Conductor cross section AWG	24 ... 12
Conductor cross section, flexible, with ferrule, with plastic sleeve	0.25 mm <sup>2</sup> ... 2.5 mm <sup>2</sup>
Conductor cross section flexible, with ferrule without plastic	0.25 mm <sup>2</sup> ... 2.5 mm <sup>2</sup>

1135751

<https://www.phoenixcontact.com/us/products/1135751>

sleeve

## Connection data

### Main circuit IN+

Connection method	Push-in connection
Stripping length	8 mm
Conductor cross section flexible	0.2 mm <sup>2</sup> ... 2.5 mm <sup>2</sup>
Conductor cross section rigid	0.2 mm <sup>2</sup> ... 4 mm <sup>2</sup>
Conductor cross section AWG	24 ... 12
Conductor cross section, flexible, with ferrule, with plastic sleeve	0.2 mm <sup>2</sup> ... 2.5 mm <sup>2</sup>
Conductor cross section flexible, with ferrule without plastic sleeve	0.2 mm <sup>2</sup> ... 2.5 mm <sup>2</sup>

### Main circuit IN-

Connection method	Push-in connection
Stripping length	8 mm
Conductor cross section flexible	0.2 mm <sup>2</sup> ... 2.5 mm <sup>2</sup>
Conductor cross section rigid	0.2 mm <sup>2</sup> ... 4 mm <sup>2</sup>
Conductor cross section AWG	24 ... 12
Conductor cross section, flexible, with ferrule, with plastic sleeve	0.2 mm <sup>2</sup> ... 2.5 mm <sup>2</sup>
Conductor cross section flexible, with ferrule without plastic sleeve	0.2 mm <sup>2</sup> ... 2.5 mm <sup>2</sup>

### Main circuit OUT

Connection method	Push-in connection
Stripping length	8 mm
Conductor cross section flexible	0.2 mm <sup>2</sup> ... 2.5 mm <sup>2</sup>
Conductor cross section rigid	0.2 mm <sup>2</sup> ... 4 mm <sup>2</sup>
Conductor cross section AWG	24 ... 12
Conductor cross section, flexible, with ferrule, with plastic sleeve	0.2 mm <sup>2</sup> ... 2.5 mm <sup>2</sup>
Conductor cross section flexible, with ferrule without plastic sleeve	0.2 mm <sup>2</sup> ... 2.5 mm <sup>2</sup>

## Signaling

Channel LED off	off (Channel switched off)
Channel LED yellow	lit (Channel switched on, channel load > 80% )
	flashing (Programming mode active)
Channel LED green	lit (Channel switched on)
Channel LED red	lit (Channel switched off, over- or undervoltage active)
	ON temporarily (Channel switched off, 5 s cool-down phase, overload or short-circuit release)
	flashing (Channel switched off, ready to be switched back on, overload or short-circuit release)
	flashing quickly (Channel switched off, external voltage at the output, possible installation error)

# PTCB E1 24DC/1A SI-R - Electronic circuit breaker



1135751

<https://www.phoenixcontact.com/us/products/1135751>

## Dimensions

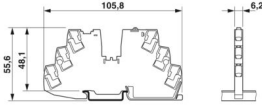
Dimensional drawing	
Width	6.2 mm
Height	105.8 mm
Depth	55.6 mm (incl. DIN rail 7.5 mm)

## Material specifications

Color	gray (RAL 7042)
Material	PBT
	PBT
Flammability rating according to UL 94	V-0

## Environmental and real-life conditions

### Ambient conditions

Degree of protection	IP20
Ambient temperature (operation)	-30 °C ... 60 °C
Ambient temperature (storage/transport)	-40 °C ... 70 °C
Altitude	≤ 3000 m up to 52 °C (amsl) ≤ 4000 m up to 46 °C (amsl)
Humidity test	96 h, 95 % RH, 40 °C
Shock (operation)	30g (IEC 60068-2-27, Test Ea)
Vibration (operation)	10 Hz ... 59.6 Hz (Amplitude ±0.35 mm; in accordance with IEC 60068-2-6, Test Fc) 59.6 Hz ... 150 Hz (Acceleration 5g; in accordance with IEC 60068-2-6, Test Fc) 5 Hz ... 100 Hz (Resonance search 4g; resonance frequency 4g; 90 min in accordance with DNV GL Class B)

## Approvals

### UL approval

Identification	UL/C-UL Listed UL 508
	UL Recognized UL 2367
	NEC Class 2 according to UL 1310
	UL/C-UL Listed ANSI/UL 121201 Class I, Division 2, Groups A, B, C, D; T4 (Hazardous Location)

### Shipbuilding approval

Identification	DNV GL
----------------	--------

### Corrosive gas test

Identification	ISA S71.04.2013 G3 Harsh Group A
----------------	----------------------------------

1135751

<https://www.phoenixcontact.com/us/products/1135751>

## DNV GL data

Temperature	D
Humidity	B
Vibration	B
EMC	B
Enclosure	A

## Standards and regulations

Standards/specifications	EN 61000-6-2
Note	EMC – Immunity for industrial areas
Standards/specifications	EN 61000-6-3
Note	EMC – Emission for residential, business and commercial properties and small operations
Standards/specifications	EN 60068-2-78
Note	Environmental influences – Moisture and heat, constant
Standards/specifications	EN 50178
Note	Equipping power installations with electronic equipment
Standards/specifications	EN 60068-2-6
Note	Environmental influences – Vibrations (sinusoidal)
Standards/specifications	EN 60068-2-27
Note	Environmental influences – Shocks
Standards/specifications	EN 60068-2-30
Note	Environmental influences – Part 2–30: Tests – Test Db: Damp heat, cyclical
Standards/specifications	EN 61373
Note	Railway applications - Rolling stock equipment - Shock and vibration tests
Standards/specifications	EN 45545-2
Note	Railway applications - Fire protection on railway vehicles - Part 2: Requirements for fire behavior of materials and components

## Mounting

Mounting type	DIN rail: 35 mm
---------------	-----------------

Drawings

Diagram

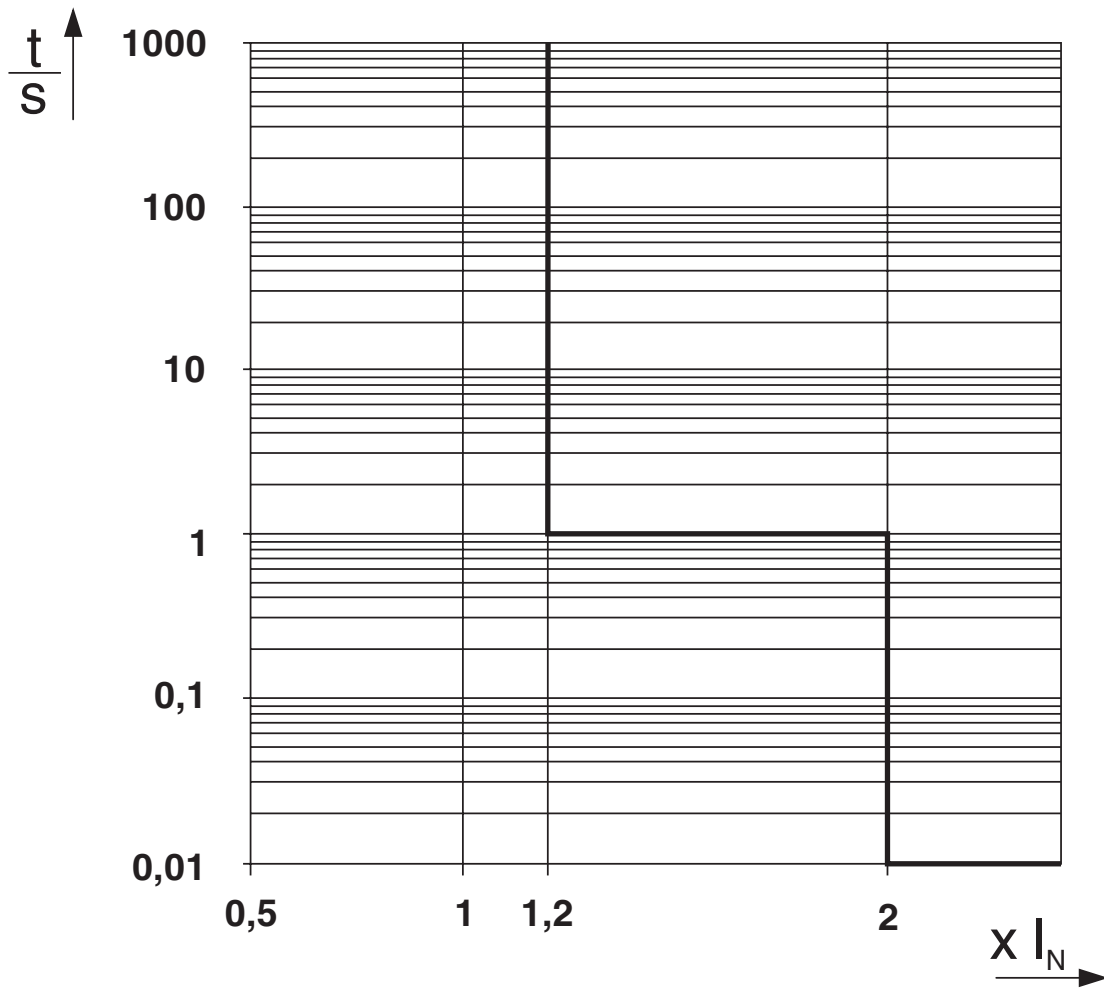

Trigger characteristic in the DC range

# PTCB E1 24DC/1A SI-R - Electronic circuit breaker

1135751

<https://www.phoenixcontact.com/us/products/1135751>

Dimensional drawing

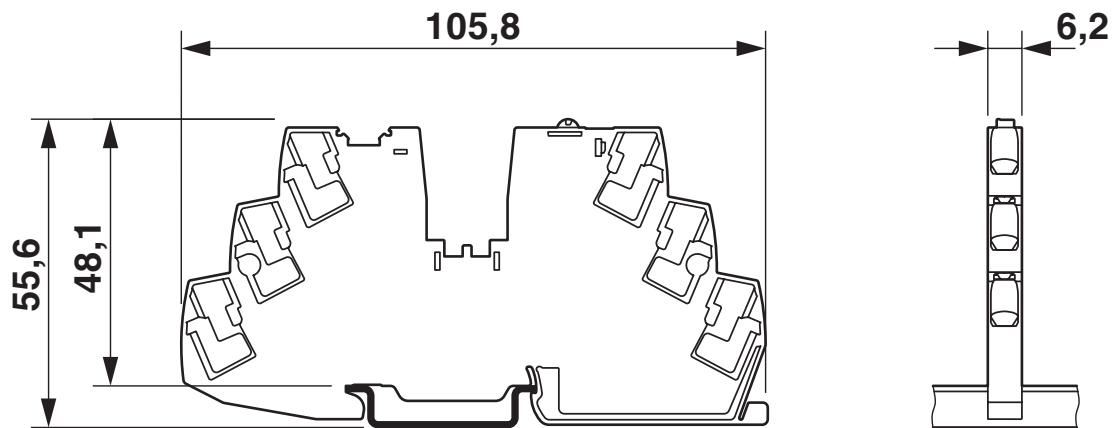

Block diagram

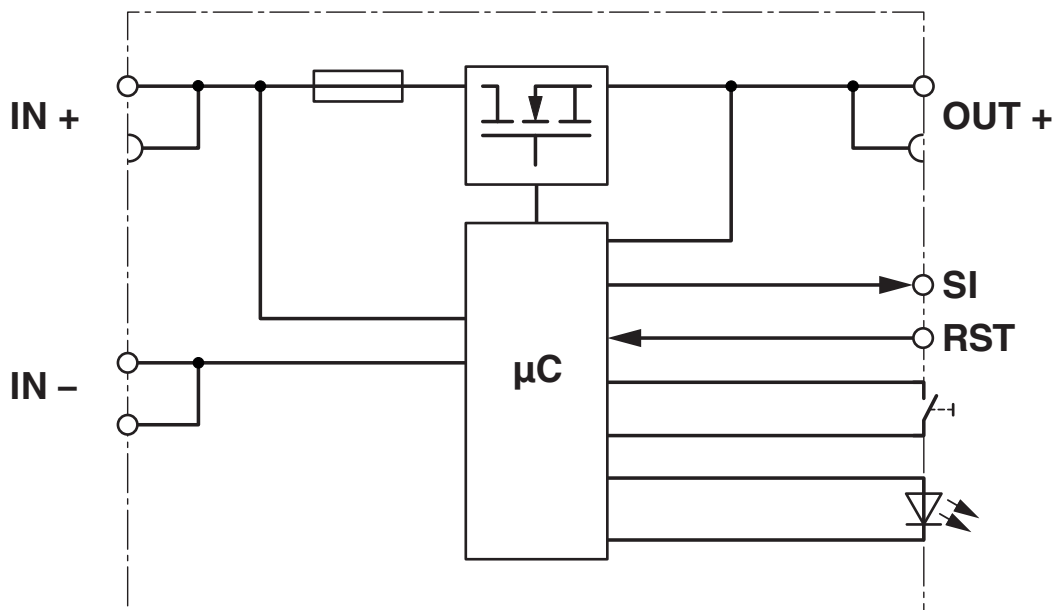

# PTCB E1 24DC/1A SI-R - Electronic circuit breaker



1135751

<https://www.phoenixcontact.com/us/products/1135751>

Diagram

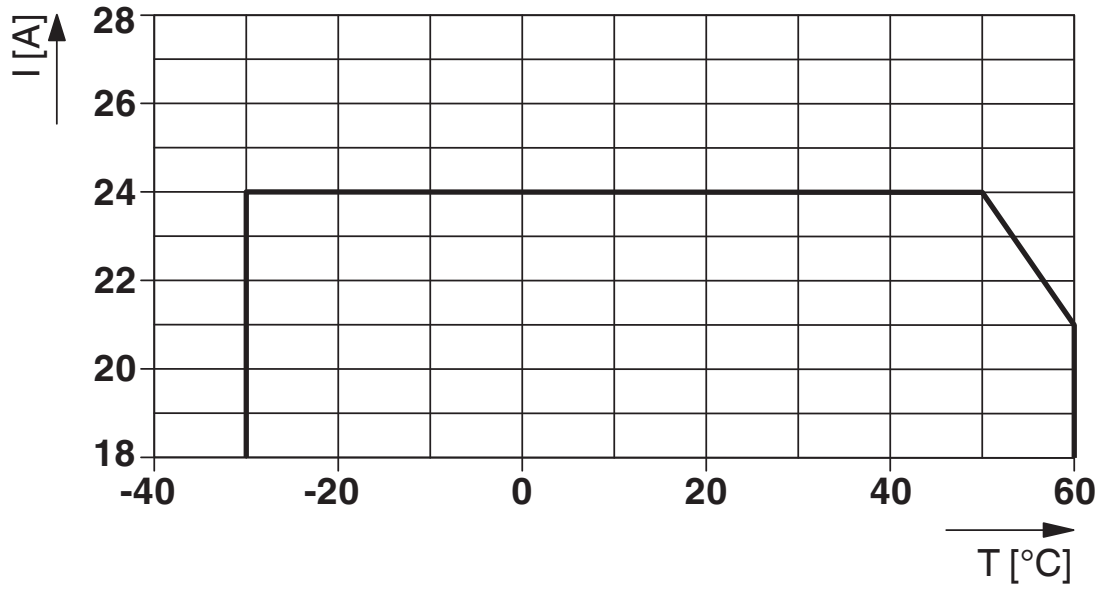

Total current input

# PTCB E1 24DC/1A SI-R - Electronic circuit breaker



1135751

<https://www.phoenixcontact.com/us/products/1135751>

## Approvals

To download certificates, visit the product detail page: <https://www.phoenixcontact.com/us/products/1135751>



**UL Recognized**

Approval ID: FILE E 317172



**DNV GL**

Approval ID: TAE00003UT



**UL Listed**

Approval ID: E123528



**cUL Listed**

Approval ID: E123528



**UL Recognized**

Approval ID: E324415-20201030



**cUL Listed**

Approval ID: E483407-20201030



**UL Listed**

Approval ID: E483407-20201030

**cULus Listed**

**cULus Listed**

# PTCB E1 24DC/1A SI-R - Electronic circuit breaker



1135751

<https://www.phoenixcontact.com/us/products/1135751>

## Classifications

### ECLASS

ECLASS-11.0	27140401
ECLASS-13.0	27140401
ECLASS-12.0	27140401

### ETIM

ETIM 9.0	EC003538
----------	----------

### UNSPSC

UNSPSC 21.0	39121400
-------------	----------

1135751

<https://www.phoenixcontact.com/us/products/1135751>

## Environmental product compliance

### EU RoHS

Fulfills EU RoHS substance requirements	Yes
Exemption	7(a), 7(c)-I

### China RoHS

Environment friendly use period (EFUP)	EFUP-50
	An article-related China RoHS declaration table can be found in the download area for the respective article under "Manufacturer declaration". For all articles with EFUP-E, no China RoHS declaration table issued and required.

### EU REACH SVHC

REACH candidate substance (CAS No.)	Lead(CAS: 7439-92-1)
SCIP	df19301d-a44f-45e9-b241-62400de74d46

### EF3.0 Climate Change

CO2e kg	0.837 kg CO2e
---------	---------------

# PTCB E1 24DC/1A SI-R - Electronic circuit breaker



1135751

<https://www.phoenixcontact.com/us/products/1135751>

## Accessories

**i** Note: Applying some accessories below might limit this product.

### FBS 2-6 - Plug-in bridge

3030336

<https://www.phoenixcontact.com/us/products/3030336>



Plug-in bridge, pitch: 6.2 mm, number of positions: 2, color: red

**i** Max. current carrying capacity: 32 A

---

### FBS 3-6 - Plug-in bridge

3030242

<https://www.phoenixcontact.com/us/products/3030242>



Plug-in bridge, pitch: 6.2 mm, number of positions: 3, color: red

**i** Max. current carrying capacity: 32 A

# PTCB E1 24DC/1A SI-R - Electronic circuit breaker



1135751

<https://www.phoenixcontact.com/us/products/1135751>

## FBS 4-6 - Plug-in bridge

3030255

<https://www.phoenixcontact.com/us/products/3030255>



Plug-in bridge, pitch: 6.2 mm, number of positions: 4, color: red

 Max. current carrying capacity: 32 A

---

## FBS 5-6 - Plug-in bridge

3030349

<https://www.phoenixcontact.com/us/products/3030349>



Plug-in bridge, pitch: 6.2 mm, number of positions: 5, color: red

 Max. current carrying capacity: 32 A

# PTCB E1 24DC/1A SI-R - Electronic circuit breaker



1135751

<https://www.phoenixcontact.com/us/products/1135751>

## FBS 10-6 - Plug-in bridge

3030271

<https://www.phoenixcontact.com/us/products/3030271>

Plug-in bridge, pitch: 6.2 mm, number of positions: 10, color: red



 Max. current carrying capacity: 32 A

---

## FBS 20-6 - Plug-in bridge

3030365

<https://www.phoenixcontact.com/us/products/3030365>

Plug-in bridge, pitch: 6.2 mm, number of positions: 20, color: red



 Max. current carrying capacity: 32 A

# PTCB E1 24DC/1A SI-R - Electronic circuit breaker



1135751

<https://www.phoenixcontact.com/us/products/1135751>

## FBS 50-6 - Plug-in bridge

3032224

<https://www.phoenixcontact.com/us/products/3032224>



Plug-in bridge, pitch: 6.2 mm, number of positions: 50, color: red

 Max. current carrying capacity: 32 A

---

## FBS 2-6 BU - Plug-in bridge

3036932

<https://www.phoenixcontact.com/us/products/3036932>



Plug-in bridge, pitch: 6.2 mm, number of positions: 2, color: blue

 Max. current carrying capacity: 32 A

# PTCB E1 24DC/1A SI-R - Electronic circuit breaker



1135751

<https://www.phoenixcontact.com/us/products/1135751>

## FBS 3-6 BU - Plug-in bridge

3036945

<https://www.phoenixcontact.com/us/products/3036945>



Plug-in bridge, pitch: 6.2 mm, number of positions: 3, color: blue

 Max. current carrying capacity: 32 A

---

## FBS 4-6 BU - Plug-in bridge

3036958

<https://www.phoenixcontact.com/us/products/3036958>



Plug-in bridge, pitch: 6.2 mm, number of positions: 4, color: blue

 Max. current carrying capacity: 32 A

---

# PTCB E1 24DC/1A SI-R - Electronic circuit breaker



1135751

<https://www.phoenixcontact.com/us/products/1135751>

## FBS 5-6 BU - Plug-in bridge

3036961

<https://www.phoenixcontact.com/us/products/3036961>



Plug-in bridge, pitch: 6.2 mm, number of positions: 5, color: blue

 Max. current carrying capacity: 32 A

---

## FBS 10-6 BU - Plug-in bridge

3032198

<https://www.phoenixcontact.com/us/products/3032198>



Plug-in bridge, pitch: 6.2 mm, number of positions: 10, color: blue

 Max. current carrying capacity: 32 A

# PTCB E1 24DC/1A SI-R - Electronic circuit breaker



1135751

<https://www.phoenixcontact.com/us/products/1135751>

## FBS 20-6 BU - Plug-in bridge

3032208

<https://www.phoenixcontact.com/us/products/3032208>

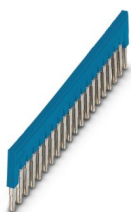

Plug-in bridge, pitch: 6.2 mm, number of positions: 20, color: blue

 Max. current carrying capacity: 32 A

---

## FBS 50-6 BU - Plug-in bridge

3032211

<https://www.phoenixcontact.com/us/products/3032211>



Plug-in bridge, pitch: 6.2 mm, number of positions: 50, color: blue

 Max. current carrying capacity: 32 A

# PTCB E1 24DC/1A SI-R - Electronic circuit breaker



1135751

<https://www.phoenixcontact.com/us/products/1135751>

## FBS 2-6 GY - Plug-in bridge

3032237

<https://www.phoenixcontact.com/us/products/3032237>



Plug-in bridge, pitch: 6.2 mm, number of positions: 2, color: gray

 Max. current carrying capacity: 32 A

---

## FBS 3-6 GY - Plug-in bridge

3032240

<https://www.phoenixcontact.com/us/products/3032240>



Plug-in bridge, pitch: 6.2 mm, number of positions: 3, color: gray

 Max. current carrying capacity: 32 A

---

# PTCB E1 24DC/1A SI-R - Electronic circuit breaker



1135751

<https://www.phoenixcontact.com/us/products/1135751>

## FBS 4-6 GY - Plug-in bridge

3032279

<https://www.phoenixcontact.com/us/products/3032279>



Plug-in bridge, pitch: 6.2 mm, number of positions: 4, color: gray

 Max. current carrying capacity: 32 A

---

## FBS 5-6 GY - Plug-in bridge

3032266

<https://www.phoenixcontact.com/us/products/3032266>



Plug-in bridge, pitch: 6.2 mm, number of positions: 5, color: gray

 Max. current carrying capacity: 32 A

---

# PTCB E1 24DC/1A SI-R - Electronic circuit breaker



1135751

<https://www.phoenixcontact.com/us/products/1135751>

## FBS 2-5 - Plug-in bridge

3030161

<https://www.phoenixcontact.com/us/products/3030161>



Plug-in bridge, pitch: 5.2 mm, number of positions: 2, length: 23 mm, color: red

 Max. current carrying capacity: 24 A

---

## FBS 3-5 - Plug-in bridge

3030174

<https://www.phoenixcontact.com/us/products/3030174>



Plug-in bridge, pitch: 5.2 mm, number of positions: 3, length: 23 mm, color: red

 Max. current carrying capacity: 24 A

---

# PTCB E1 24DC/1A SI-R - Electronic circuit breaker



1135751

<https://www.phoenixcontact.com/us/products/1135751>

## FBS 4-5 - Plug-in bridge

3030187

<https://www.phoenixcontact.com/us/products/3030187>



Plug-in bridge, pitch: 5.2 mm, number of positions: 4, length: 23 mm, color: red

 Max. current carrying capacity: 24 A

---

## FBS 5-5 - Plug-in bridge

3030190

<https://www.phoenixcontact.com/us/products/3030190>



Plug-in bridge, pitch: 5.2 mm, number of positions: 5, length: 23 mm, color: red

 Max. current carrying capacity: 24 A

# PTCB E1 24DC/1A SI-R - Electronic circuit breaker



1135751

<https://www.phoenixcontact.com/us/products/1135751>

## FBS 10-5 - Plug-in bridge

3030213

<https://www.phoenixcontact.com/us/products/3030213>



Plug-in bridge, pitch: 5.2 mm, number of positions: 10, length: 23 mm, color: red

 Max. current carrying capacity: 24 A

---

## FBS 20-5 - Plug-in bridge

3030226

<https://www.phoenixcontact.com/us/products/3030226>



Plug-in bridge, pitch: 5.2 mm, number of positions: 20, color: red

 Max. current carrying capacity: 24 A

# PTCB E1 24DC/1A SI-R - Electronic circuit breaker



1135751

<https://www.phoenixcontact.com/us/products/1135751>

## FBS 50-5 - Plug-in bridge

3038930

<https://www.phoenixcontact.com/us/products/3038930>



Plug-in bridge, pitch: 5.2 mm, number of positions: 50, color: red

 Max. current carrying capacity: 24 A

---

## FBS 2-5 BU - Plug-in bridge

3036877

<https://www.phoenixcontact.com/us/products/3036877>



Plug-in bridge, pitch: 5.2 mm, number of positions: 2, color: blue

 Max. current carrying capacity: 24 A

---

# PTCB E1 24DC/1A SI-R - Electronic circuit breaker

1135751

<https://www.phoenixcontact.com/us/products/1135751>

## FBS 3-5 BU - Plug-in bridge

3036880

<https://www.phoenixcontact.com/us/products/3036880>



Plug-in bridge, pitch: 5.2 mm, number of positions: 3, color: blue

 Max. current carrying capacity: 24 A

---

## FBS 4-5 BU - Plug-in bridge

3036893

<https://www.phoenixcontact.com/us/products/3036893>



Plug-in bridge, pitch: 5.2 mm, number of positions: 4, color: blue

 Max. current carrying capacity: 24 A

# PTCB E1 24DC/1A SI-R - Electronic circuit breaker



1135751

<https://www.phoenixcontact.com/us/products/1135751>

## FBS 5-5 BU - Plug-in bridge

3036903

<https://www.phoenixcontact.com/us/products/3036903>



Plug-in bridge, pitch: 5.2 mm, number of positions: 5, color: blue

 Max. current carrying capacity: 24 A

---

## FBS 10-5 BU - Plug-in bridge

3036916

<https://www.phoenixcontact.com/us/products/3036916>



Plug-in bridge, pitch: 5.2 mm, number of positions: 10, color: blue

 Max. current carrying capacity: 24 A

# PTCB E1 24DC/1A SI-R - Electronic circuit breaker



1135751

<https://www.phoenixcontact.com/us/products/1135751>

## FBS 20-5 BU - Plug-in bridge

3036929

<https://www.phoenixcontact.com/us/products/3036929>



Plug-in bridge, pitch: 5.2 mm, number of positions: 20, color: blue

 Max. current carrying capacity: 24 A

---

## FBS 50-5 BU - Plug-in bridge

3032114

<https://www.phoenixcontact.com/us/products/3032114>



Plug-in bridge, pitch: 5.2 mm, number of positions: 50, color: blue

 Max. current carrying capacity: 24 A

# PTCB E1 24DC/1A SI-R - Electronic circuit breaker



1135751

<https://www.phoenixcontact.com/us/products/1135751>

## FBS 2-5 GY - Plug-in bridge

3038969

<https://www.phoenixcontact.com/us/products/3038969>



Plug-in bridge, pitch: 5.2 mm, number of positions: 2, color: gray

 Max. current carrying capacity: 24 A

---

## FBS 3-5 GY - Plug-in bridge

3038972

<https://www.phoenixcontact.com/us/products/3038972>



Plug-in bridge, pitch: 5.2 mm, number of positions: 3, color: gray

 Max. current carrying capacity: 24 A

---

# PTCB E1 24DC/1A SI-R - Electronic circuit breaker



1135751

<https://www.phoenixcontact.com/us/products/1135751>

## FBS 4-5 GY - Plug-in bridge

3038985

<https://www.phoenixcontact.com/us/products/3038985>



Plug-in bridge, pitch: 5.2 mm, number of positions: 4, color: gray

 Max. current carrying capacity: 24 A

---

## FBS 5-5 GY - Plug-in bridge

3038998

<https://www.phoenixcontact.com/us/products/3038998>



Plug-in bridge, pitch: 5.2 mm, number of positions: 5, color: gray

 Max. current carrying capacity: 24 A

---

# PTCB E1 24DC/1A SI-R - Electronic circuit breaker



1135751

<https://www.phoenixcontact.com/us/products/1135751>

## RB ST 10-(2,5/4) - Reducing bridge

3030873

<https://www.phoenixcontact.com/us/products/3030873>



Reducing bridge, pitch: 10 mm, number of positions: 2, length: 36 mm, color: red

---

## PT 4 - Feed-through terminal block

3211757

<https://www.phoenixcontact.com/us/products/3211757>

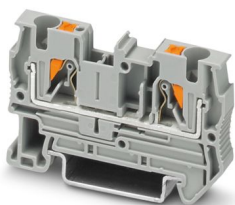

Feed-through terminal block, nom. voltage: 800 V, nominal current: 32 A, number of connections: 2, connection method: Push-in connection, Rated cross section: 4 mm<sup>2</sup>, cross section: 0.2 mm<sup>2</sup> - 6 mm<sup>2</sup>, mounting type: NS 35/7,5, NS 35/15, color: gray

# PTCB E1 24DC/1A SI-R - Electronic circuit breaker



1135751

<https://www.phoenixcontact.com/us/products/1135751>

## PT 4-TWIN - Feed-through terminal block

3211771

<https://www.phoenixcontact.com/us/products/3211771>



Feed-through terminal block, nom. voltage: 800 V, nominal current: 32 A, number of connections: 3, connection method: Push-in connection, Rated cross section: 4 mm<sup>2</sup>, cross section: 0.2 mm<sup>2</sup> - 6 mm<sup>2</sup>, mounting type: NS 35/7,5, NS 35/15, color: gray

---

## PT 4-QUATTRO - Feed-through terminal block

3211797

<https://www.phoenixcontact.com/us/products/3211797>

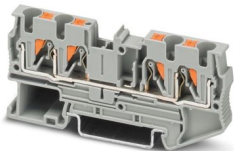

Feed-through terminal block, nom. voltage: 800 V, nominal current: 32 A, number of connections: 4, connection method: Push-in connection, Rated cross section: 4 mm<sup>2</sup>, cross section: 0.2 mm<sup>2</sup> - 6 mm<sup>2</sup>, mounting type: NS 35/7,5, NS 35/15, color: gray

1135751

<https://www.phoenixcontact.com/us/products/1135751>

## ST 4 - Feed-through terminal block

3031364

<https://www.phoenixcontact.com/us/products/3031364>

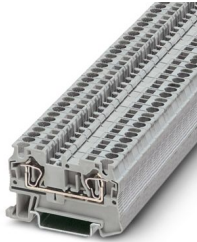

Feed-through terminal block, nom. voltage: 800 V, nominal current: 32 A, number of connections: 2, connection method: Spring-cage connection, 1 level, Rated cross section: 4 mm<sup>2</sup>, cross section: 0.08 mm<sup>2</sup> - 6 mm<sup>2</sup>, mounting type: NS 35/7,5, NS 35/15, color: gray

---

## ST 4-TWIN - Feed-through terminal block

3031393

<https://www.phoenixcontact.com/us/products/3031393>



Feed-through terminal block, nom. voltage: 800 V, nominal current: 32 A, number of connections: 3, connection method: Spring-cage connection, Rated cross section: 4 mm<sup>2</sup>, cross section: 0.08 mm<sup>2</sup> - 6 mm<sup>2</sup>, mounting type: NS 35/7,5, NS 35/15, color: gray

# PTCB E1 24DC/1A SI-R - Electronic circuit breaker



1135751

<https://www.phoenixcontact.com/us/products/1135751>

## ST 4-QUATTRO - Feed-through terminal block

3031445

<https://www.phoenixcontact.com/us/products/3031445>



Feed-through terminal block, nom. voltage: 800 V, nominal current: 32 A, number of connections: 4, connection method: Spring-cage connection, 1 level, Rated cross section: 4 mm<sup>2</sup>, cross section: 0.08 mm<sup>2</sup> - 6 mm<sup>2</sup>, mounting type: NS 35/7,5, NS 35/15, color: gray

---

## QTC 2,5 - Feed-through terminal block

3206416

<https://www.phoenixcontact.com/us/products/3206416>



Feed-through terminal block, nom. voltage: 800 V, nominal current: 24 A, number of connections: 2, connection method: Quick connection, 1 level, Rated cross section: 2.5 mm<sup>2</sup>, cross section: 0.5 mm<sup>2</sup> - 2.5 mm<sup>2</sup>, mounting type: NS 35/7,5, NS 35/15, color: gray

# PTCB E1 24DC/1A SI-R - Electronic circuit breaker



1135751

<https://www.phoenixcontact.com/us/products/1135751>

## QTC 2,5-TWIN - Feed-through terminal block

3206445

<https://www.phoenixcontact.com/us/products/3206445>



Feed-through terminal block, nom. voltage: 800 V, nominal current: 24 A, number of connections: 3, connection method: Quick connection, 1 level, Rated cross section: 2.5 mm<sup>2</sup>, cross section: 0.5 mm<sup>2</sup> - 2.5 mm<sup>2</sup>, mounting type: NS 35/7,5, NS 35/7,5, color: gray

---

## QTC 2,5-QUATTRO - Feed-through terminal block

3206446

<https://www.phoenixcontact.com/us/products/3206446>

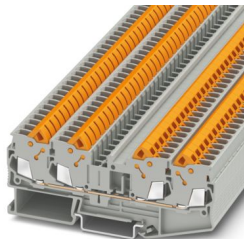

Feed-through terminal block, nom. voltage: 800 V, nominal current: 24 A, number of connections: 4, connection method: Quick connection, 1 level, Rated cross section: 2.5 mm<sup>2</sup>, cross section: 0.5 mm<sup>2</sup> - 2.5 mm<sup>2</sup>, mounting type: NS 35/7,5, NS 35/7,5, color: gray

# PTCB E1 24DC/1A SI-R - Electronic circuit breaker



1135751

<https://www.phoenixcontact.com/us/products/1135751>

## PT 2,5 - Feed-through terminal block

3209510

<https://www.phoenixcontact.com/us/products/3209510>



Feed-through terminal block, nom. voltage: 800 V, nominal current: 24 A, number of connections: 2, number of positions: 1, connection method: Push-in connection, Rated cross section: 2.5 mm<sup>2</sup>, cross section: 0.14 mm<sup>2</sup> - 4 mm<sup>2</sup>, mounting type: NS 35/7,5, NS 35/15, color: gray

## PT 2,5-TWIN - Feed-through terminal block

3209549

<https://www.phoenixcontact.com/us/products/3209549>

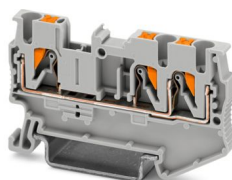

Feed-through terminal block, nom. voltage: 800 V, nominal current: 24 A, number of connections: 3, connection method: Push-in connection, Rated cross section: 2.5 mm<sup>2</sup>, cross section: 0.14 mm<sup>2</sup> - 4 mm<sup>2</sup>, mounting type: NS 35/7,5, NS 35/15, color: gray

# PTCB E1 24DC/1A SI-R - Electronic circuit breaker



1135751

<https://www.phoenixcontact.com/us/products/1135751>

## PT 2,5-QUATTRO - Feed-through terminal block

3209578

<https://www.phoenixcontact.com/us/products/3209578>

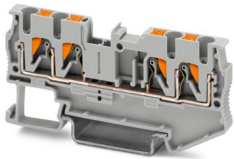

Feed-through terminal block, nom. voltage: 800 V, nominal current: 24 A, number of connections: 4, connection method: Push-in connection, Rated cross section: 2.5 mm<sup>2</sup>, cross section: 0.14 mm<sup>2</sup> - 4 mm<sup>2</sup>, mounting type: NS 35/7,5, NS 35/15, color: gray

---

## ST 2,5 - Feed-through terminal block

3031212

<https://www.phoenixcontact.com/us/products/3031212>



Feed-through terminal block, nom. voltage: 800 V, nominal current: 24 A, number of connections: 2, connection method: Spring-cage connection, Rated cross section: 2.5 mm<sup>2</sup>, cross section: 0.08 mm<sup>2</sup> - 4 mm<sup>2</sup>, mounting type: NS 35/7,5, NS 35/15, color: gray

# PTCB E1 24DC/1A SI-R - Electronic circuit breaker



1135751

<https://www.phoenixcontact.com/us/products/1135751>

## ST 2,5-TWIN - Feed-through terminal block

3031241

<https://www.phoenixcontact.com/us/products/3031241>

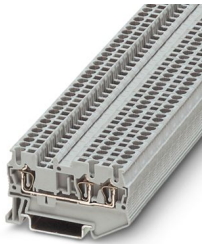

Feed-through terminal block, nom. voltage: 800 V, nominal current: 24 A, number of connections: 3, connection method: Spring-cage connection, Rated cross section: 2.5 mm<sup>2</sup>, cross section: 0.08 mm<sup>2</sup> - 4 mm<sup>2</sup>, mounting type: NS 35/7,5, NS 35/15, color: gray

---

## ST 2,5-QUATTRO - Feed-through terminal block

3031306

<https://www.phoenixcontact.com/us/products/3031306>

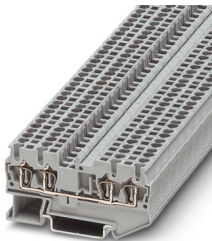

Feed-through terminal block, nom. voltage: 800 V, nominal current: 24 A, number of connections: 4, connection method: Spring-cage connection, Rated cross section: 2.5 mm<sup>2</sup>, cross section: 0.08 mm<sup>2</sup> - 4 mm<sup>2</sup>, mounting type: NS 35/7,5, NS 35/15, color: gray

# PTCB E1 24DC/1A SI-R - Electronic circuit breaker



1135751

<https://www.phoenixcontact.com/us/products/1135751>

## QTC 1,5 - Feed-through terminal block

3205019

<https://www.phoenixcontact.com/us/products/3205019>



Feed-through terminal block, nom. voltage: 800 V, nominal current: 17.5 A, number of connections: 2, connection method: Quick connection, 1 level, Rated cross section: 1.5 mm<sup>2</sup>, cross section: 0.25 mm<sup>2</sup> - 1.5 mm<sup>2</sup>, mounting type: NS 35/7,5, NS 35/15, color: gray

---

## QTC 1,5-TWIN - Feed-through terminal block

3205048

<https://www.phoenixcontact.com/us/products/3205048>



Feed-through terminal block, nom. voltage: 800 V, nominal current: 17.5 A, number of connections: 3, connection method: Quick connection, 1 level, Rated cross section: 1.5 mm<sup>2</sup>, cross section: 0.25 mm<sup>2</sup> - 1.5 mm<sup>2</sup>, mounting type: NS 35/7,5, NS 35/7,5, color: gray

# PTCB E1 24DC/1A SI-R - Electronic circuit breaker



1135751

<https://www.phoenixcontact.com/us/products/1135751>

## QTC 1,5-QUATTRO - Feed-through terminal block

3205077

<https://www.phoenixcontact.com/us/products/3205077>



Feed-through terminal block, nom. voltage: 800 V, nominal current: 17.5 A, number of connections: 4, connection method: Quick connection, 1 level, Rated cross section: 1.5 mm<sup>2</sup>, cross section: 0.25 mm<sup>2</sup> - 1.5 mm<sup>2</sup>, mounting type: NS 35/7,5, NS 35/7,5, color: gray

---

## PT 10 - Feed-through terminal block

3212120

<https://www.phoenixcontact.com/us/products/3212120>

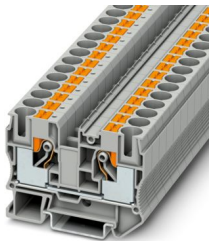

Feed-through terminal block, nom. voltage: 1000 V, nominal current: 57 A, number of connections: 2, connection method: Push-in connection, Rated cross section: 10 mm<sup>2</sup>, cross section: 0.5 mm<sup>2</sup> - 16 mm<sup>2</sup>, mounting type: NS 35/7,5, NS 35/15, color: gray

# PTCB E1 24DC/1A SI-R - Electronic circuit breaker



1135751

<https://www.phoenixcontact.com/us/products/1135751>

## ST 10 - Feed-through terminal block

3036110

<https://www.phoenixcontact.com/us/products/3036110>



Feed-through terminal block, nom. voltage: 1000 V, nominal current: 57 A, number of connections: 2, connection method: Spring-cage connection, Rated cross section: 10 mm<sup>2</sup>, cross section: 0.2 mm<sup>2</sup> - 16 mm<sup>2</sup>, mounting type: NS 35/7,5, NS 35/15, color: gray

---

## ZB 6:UNBEDRUCKT - Zack marker strip

1051003

<https://www.phoenixcontact.com/us/products/1051003>



Zack marker strip, Strip, white, unlabeled, can be labeled with: PLOTMARK, CMS-P1-PLOTTER, mounting type: latching, for terminal block width: 6.2 mm, Number of individual labels: 10, text field height: 10.5 mm, text field width: 6.15 mm

# PTCB E1 24DC/1A SI-R - Electronic circuit breaker



1135751

<https://www.phoenixcontact.com/us/products/1135751>

## ZBF 6:UNBEDRUCKT - Zack Marker strip, flat

0808710

<https://www.phoenixcontact.com/us/products/0808710>



Zack Marker strip, flat, Strip, white, unlabeled, can be labeled with: PLOTMARK, CMS-P1-PLOTTER, mounting type: latching, for terminal block width: 6.2 mm, Number of individual labels: 10, text field height: 6.15 mm, text field width: 5.15 mm

---

## UCT-TM 6 - Marker for terminal blocks

0828736

<https://www.phoenixcontact.com/us/products/0828736>



Marker for terminal blocks, Sheet, white, unlabeled, can be labeled with: TOPMARK NEO, TOPMARK LASER, BLUEMARK ID COLOR, BLUEMARK ID, BLUEMARK CLED, THERMOMARK PRIME, THERMOMARK CARD 2.0, THERMOMARK CARD, mounting type: latching, for terminal block width: 6.2 mm, Number of individual labels: 60, text field height: 10.5 mm, text field width: 5.6 mm

# PTCB E1 24DC/1A SI-R - Electronic circuit breaker



1135751

<https://www.phoenixcontact.com/us/products/1135751>

## UCT-TM 6 CUS - Marker for terminal blocks

0829602

<https://www.phoenixcontact.com/us/products/0829602>

Marker for terminal blocks, can be ordered: by sheet, white, labeled according to customer specifications, mounting type: snap into tall marker groove, for terminal block width: 6.2 mm, Number of individual labels: 60



---

## US-TML (104X3,8) - Marker for terminal blocks

0830768

<https://www.phoenixcontact.com/us/products/0830768>

Marker for terminal blocks, Card, white, unlabeled, can be labeled with: BLUEMARK ID COLOR, BLUEMARK ID, THERMOMARK PRIME, THERMOMARK CARD 2.0, THERMOMARK CARD, mounting type: adhesive, Number of individual labels: 22, text field height: 3.8 mm, text field width: 104 mm



## PTCB E1 24DC/1A SI-R - Electronic circuit breaker

1135751

<https://www.phoenixcontact.com/us/products/1135751>



## TTC-6P-T3-24DC-PT-I - Type 3 surge protection device

1027586

<https://www.phoenixcontact.com/us/products/1027586>



Type 3 surge protection, consisting of protective plug and base element, with integrated status indicator for 24 V DC power supplies

---

## PTTB 1,5/S - Double-level terminal block

3208511

<https://www.phoenixcontact.com/us/products/3208511>



Double-level terminal block, nom. voltage: 500 V, nominal current: 16 A, connection method: Push-in connection, 1st and 2nd level, Rated cross section: 1.5 mm<sup>2</sup>, cross section: 0.14 mm<sup>2</sup> - 1.5 mm<sup>2</sup>, mounting type: NS 35/7,5, NS 35/15, color: gray

# PTCB E1 24DC/1A SI-R - Electronic circuit breaker



1135751

<https://www.phoenixcontact.com/us/products/1135751>

## PTTB 2,5 - Double-level terminal block

3210567

<https://www.phoenixcontact.com/us/products/3210567>



Double-level terminal block, nom. voltage: 500 V, nominal current: 22 A, connection method: Push-in connection, 1st and 2nd level, Rated cross section: 2.5 mm<sup>2</sup>, cross section: 0.14 mm<sup>2</sup> - 4 mm<sup>2</sup>, mounting type: NS 35/7,5, NS 35/15, color: gray

---

## PTTB 4 - Double-level terminal block

3211786

<https://www.phoenixcontact.com/us/products/3211786>



Double-level terminal block, nom. voltage: 500 V, nominal current: 28 A, connection method: Push-in connection, 1st and 2nd level, Rated cross section: 4 mm<sup>2</sup>, cross section: 0.2 mm<sup>2</sup> - 6 mm<sup>2</sup>, mounting type: NS 35/7,5, NS 35/15, color: gray

# PTCB E1 24DC/1A SI-R - Electronic circuit breaker



1135751

<https://www.phoenixcontact.com/us/products/1135751>

## DB 50- 90 BK - Wire bridge

2820916

<https://www.phoenixcontact.com/us/products/2820916>

Flexible wire loop bridge, 50-pos., conductor cross-section: 0.5 mm<sup>2</sup>, loop length: 90 mm, ferrule length: 8 mm, color: black



---

## DB 50- 90 BU - Wire bridge

2821180

<https://www.phoenixcontact.com/us/products/2821180>

Flexible wire loop bridge, 50-pos., conductor cross-section: 0.5 mm<sup>2</sup>, loop length: 90 mm, ferrule length: 8 mm, color: blue

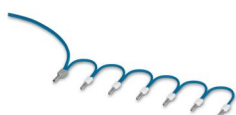

# PTCB E1 24DC/1A SI-R - Electronic circuit breaker



1135751

<https://www.phoenixcontact.com/us/products/1135751>

## DB 50- 90 GY - Wire bridge

2820929

<https://www.phoenixcontact.com/us/products/2820929>

Flexible wire loop bridge, 50-pos., conductor cross-section: 0.5 mm<sup>2</sup>, loop length: 90 mm, ferrule length: 8 mm, color: gray



---

## DB 50- 90 RD - Wire bridge

2864639

<https://www.phoenixcontact.com/us/products/2864639>

Flexible wire loop bridge, 50-pos., conductor cross-section: 0.5 mm<sup>2</sup>, loop length: 90 mm, ferrule length: 8 mm, color: red



---

Phoenix Contact 2024 © - all rights reserved  
<https://www.phoenixcontact.com>

Phoenix Contact USA  
586 Fulling Mill Road  
Middletown, PA 17057, United States  
(+717) 944-1300  
[info@phoenixcon.com](mailto:info@phoenixcon.com)